

# Precision Truck Training

Technical & Product Training  
for the Diesel Truck Specialist

## Course IV Mid-Range Diesels

By James Edward Godfrey with contributions by  
Robert James Godfrey and David John Godfrey, CPA

1st Edition—June, 2000



Career-builder training by  
Truck Marketing Institute

**First Edition – 2000**

PREVIOUSLY PUBLISHED AS  
*Precision Truck Selling*  
*Course IV*  
*Mid-Range Diesels*

Copyright © 2000

by

**Truck Marketing Institute**

1090 Eugenia Place

P.O. Box 5000

Carpinteria, California 93014-5000

Phone: 1-805-684-4558

Fax: 1-805-684-2868

All Rights reserved

Printed in the U.S.A.

## Preface

The selection and application of mid-range diesel trucks is the entire thrust of this course. On that premise, it is interesting to note that in terms of chronological development, this is the fourth in TMI's series of Precision Truck Training courses. Course I is confined to the light-duty field, Course II is mainly medium-duty in its orientation, while Course III deals solely with heavy-duty trucks and tractors. In the progression up through the truck weight classes, you'll recognize now that Course IV is out of sequence. Market timing is the reason; in the North American truck market, mid-range diesels were launched for widespread usage with the decade of the 1980s.

Now, before we get into the course itself, a few words about applicability of this course to people in the truck industry: Regardless of however much or little truck experience a person may possess, one ought to approach mid-range diesels with the uncluttered and receptive mind of a trainee starting on *Day-One*. Although a considerable amount of truck knowledge is transferrable between weight classes, there are important differences, too. Often subtle in nature, these differences are all the more dangerous if they go unrecognized. During the decades of the 1960s and 70s, mid-range diesels served well where the engines were prudently applied. But there were some horror stories, too—stories of engine failures through misapplications. Throughout Course IV we are dedicated to a goal of correct application of every mid-range diesel.

We hope that you will derive substantial benefit and preparedness to meet the challenges of the mid-range diesels. Realizing that you must be anxious to get started, we have kept these next introductory pages purposely brief. So read the introduction to gain an understanding of how this course functions, and how we can help you. After that, good studying, and send us your first completed test as soon as you can.

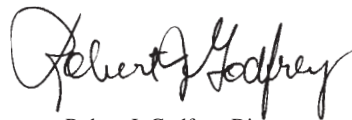
A handwritten signature in black ink, reading "Robert J. Godfrey". The signature is written in a cursive, flowing style with a large initial "R".

Robert J. Godfrey, Director

## The Course Objectives

Whether you sell trucks or operate a fleet for a living, you will be more successful if you can listen to your customer, find out what their needs are, and then give them choices that reflect your professional expertise.

“Precision Truck Training: Course IV” represents one of the most comprehensive self-study programs for persons entering the medium-duty truck sales engineering field. Selling skills courses are many and varied. Courses like this are usually found only in resident programs put on by the truck manufacturers at considerable expense. It would probably take you two 40-hour classes to equal the training that Course IV provides.

As a graduate of this course, you will be expected to have the ability to analyze any commercial transportation objective and then to plan and propose equipment that will fulfill the transportation goal most efficiently and economically through the vehicle’s normal life cycle. That is the ultimate objective of Course IV.

## How We Get There

Ahead of you lies a 10 lesson course that will average about 40 hours of study time to complete, including completion of an open book exam for each lesson. Take a moment to thumb through the textbook and look over the table of contents for each lesson to review the subject matter. And following Lesson 10 you will find the Tables & Data section, a key reference source during your studies. But understand also, your training objectives include a working knowledge of all the major makes of mid-range diesel trucks. To that end, rely on your TMI Truck Data Digest for detailed specifications. Chances are, this textbook will serve as your personal truck handbook over the years.

To a certain extent, each lesson builds upon the other. You will start with Lesson 1, study it completely, do the test, submit it for corrections, and then move on. Submit a test after each lesson—do not send them in all at once. We strongly recommend that you do the lessons in the order they are presented.

***TMI Headquarters  
1090 Eugenia Place  
Carpinteria, CA  
Ph. (805) 684-4558  
Fax (805) 684-2868***

---



## Truck Marketing Institute: A History

Truck Marketing Institute was founded in 1964 by James E. Godfrey to write specialized training courses for those who sell and operate trucks. Until TMI, this training was provided on a “catch as catch can” basis by truck manufacturer training personnel, area managers, advertising agencies, etcetera.

TMI is a privately owned school that operates in cooperation with the truck manufacturers and their suppliers. We strive to maintain up-to-date courses and manufacturers endorse them as “factory approved training.”

Truck Marketing Institute is an accredited member of the Distance Education and Training Council, located in Washington, D.C. As an accredited member, you can be assured that we meet these rigid guidelines:



- Qualified faculty and staff
- Screening of applicants
- Reasonable tuitions
- Sound educational course content
- A fair tuition refund policy
- A history of student success and satisfaction
- The financial stability to ensure a quality educational service.

# LESSON 1

## Course Objectives

What are the learning objectives of this course? Actually, those goals can best be stated in terms of the following personal performance objective:

*As a graduate of this course, you should have the ability to professionally analyze any truck application within the weight Classes of mid-range diesel trucks; then plan and propose the equipped truck to fulfill the hauling requirements with maximum efficiency and economy of operation.*

If you have glanced through this textbook, possibly you've observed that Precision Truck Training—Course IV offers a broad industry-wide view of mid-range diesels. Part of being professional is in not being parochial—in not being a stranger to trucks outside your own product line. To close that gap, Course IV aims at three knowledge objectives: (1) understanding the fundamentals of mid-range diesel trucks—operating costs, performance, load capacity, weight distribution and other application essentials; (2) full knowledge of your own product line; and (3) developing a familiarity with other truck makes so that you can most effectively position and present your truck proposals.

## Lesson Objectives

Lesson 1 digs for the footings and sets the foundation of critical fundamentals for everything that builds in the other nine lessons. You'll need to know the territorial boundaries, and at least have a cursory familiarity with the types of trucks powered by mid-range diesels. Just

about everything having to do with trucks involves some type of measurement: load, weight and capacity measurements, and, highly important when talking diesels are cost measurements. In Lesson 1 you'll receive an introduction to the metric system—or to the U.S. customary measures system if you're in a metric country.

And, yes, there is a brief overlay of history in this lesson as well. Therein are the answers to questions such as these: In Europe why have virtually all but the lightest trucks been diesel-powered for decades? In North America, until the 1979-80 period, why were diesels only a fringe factor in the industry's medium-duty truck registrations? What factors influence dieselization, and what lies ahead? What more can we say, other than "tune in" to Lesson 1. Good studying.

## LESSON 1—CONTENTS

- 17 Truck Weight Ratings
- 18 Truck Weight Rating Classes and Groups
- 19 Truck Chassis Types
- 21 Cab Types for Mid-Range Diesels
- 22 Basic Truck Dimensions
- 23 Front Axles: A Choice of Locations?
- 24 Weights and Measures—Take Your Choice
- 24 Metric and Systeme Internationale (S.I.)
- 25 Comparing Customary and Metric Measures
- 25 Remember the Years of Cheap Gasoline?
- 26 Meanwhile, In Europe, Britain, Japan
- 26 The Problem: Worldwide Oil Depletion
- 27 Solutions: Incentives for Production and Conservation
- 28 How to Calculate Fuel Cost as a Truck Expense
- 31 How to Calculate Fuel Costs in Metrics
- 34 Inflation and Higher Fuel Prices?
- 36 Higher Fuel Prices Mean Bigger Diesel Savings
- 38 Commentary: The TMI Teaching Philosophy

## Cab Types for Mid-Range Diesels

Yes, we'll limit the discussion to the mid-range diesel truck category. (No high-rise cab-overs with double-bunk sleepers.) Here are the several cab types and their distinctive features:

**Conventional Cab.** To be exact, the word *conventional* applies more to the front end design than to the cab itself. What we're talking about here is a normal positioning of engine, steering gear, hood and front fenders—all located ahead of the fire wall, the panel that separates engine compartment and cab interior. Bumper to back of cab dimension (BBC) ranges from about 102" to 108" for medium-duty trucks with conventional cabs.

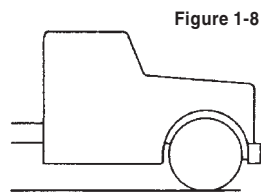

**Short Conventional Cab** is also known as Cab Forward. As compared with conventional layout, hood and front fenders are shortened, cab is mounted higher above frame and about 12" closer to front of frame. This reduces the BBC dimension (90 to 98" BBC is typical), allowing shorter wheelbase and shorter overall length for any given body length. Or, a longer body may be used within a specified overall truck length. Compared with conventional design, the front axle carries a slightly higher proportion of the total weight. Good engine accessibility can be achieved by use of a butterfly hood, alligator hood, swing-out side panels, or best of all, a tilt-hood design.

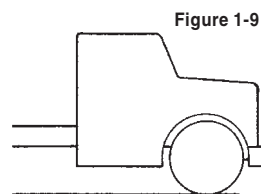

**Tilt Cab** gets its name from the fact that it may be raised from the rear, tilting it forward to completely expose the engine compartment. Cab is pivoted from sturdy hinge brackets at front and snaps down into a body mount at rear. Safety catch minimizes the risk of accidental tilting. Cab may be spring counter balanced for ease of tilting, or a hydraulic cylinder may be used for tilting, effort being applied through a hand pump. **Cab Over Engine (COE)** is also a common term for tilt cabs.

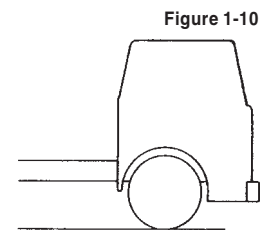

# LESSON 2

## Lesson Objectives

Before we say a word about objectives, turn the page and scan the subject titles for Lesson 2. No, it's not all a mistake, and no, you've not been seduced into taking an accounting course. Really, what you will be offered in this lesson is a layman's-level exposure to the economic facts of life as far as gasoline and diesel trucks are concerned. Lesson 1 opened the door with some graphic fuel cost comparisons. Now you'll see the big picture. But the trouble is, the picture is changing. Year by year, inflation can make a moving target out of the whole cost picture. So you need to understand the potential effects of inflation on truck costs.

This has been said before, but it bears frequent repetition: The choice between gasoline- and diesel-powered trucks is essentially an economic decision. Step by step, in the topics of Lesson 2, you'll develop the understandings and learn the uses of the tools to build a diesel proposal to any needed degree of sophistication.

Any skepticism at this point? Assuming you're on the selling side of the desk, does this intense examination of truck costs seem remote or beyond your needs? Granted, these are the worries of the truck owner, but more and more, the salesperson will be expected to recommend the exact truck that will cost the least to operate. By knowing all the nuances of truck operating costs, you will be in a much better position to advise and counsel. Remember, the linehaul 18-wheelers and P & D vans of the common carriers are minority applications. Far more Group 5, 6 and 7 trucks pull duty in private hauling jobs. Hence, your wisdom can generate the appreciation of those many "nontruckers" who just happen to depend on trucks to keep their factories or stores going.

## LESSON 2-CONTENTS

- 41** Effect of Inflation on Truck Operating Costs
- 42** Compensating Through Use of Inflation Factors
- 44** A Tale of Two Trucks: Diesel vs. Gasoline
- 45** Comparing Fuel Costs: Diesel vs. Gasoline
- 46** Comparing Running Costs Other Than Fuel
- 47** Comparing Truck Ownership Costs
- 48** Cost Summaries: Diesel vs. Gasoline
- 49** Analysis of Comparative Cash Demands
- 51** Depreciation: What Is it?
- 51** Depreciation: 1981 to 1986
- 52** Asset Expense Deductions: Then and Now
- 53** MACRS: Another Depreciation System
- 54** Trade in Allowances
- 54** Leasing: The Basics
- 55** Finance Leasing: Lower Payments?
- 55** Full Service Leasing
- 55** Contract Maintenance
- 56** Leasing: Advantages
- 56** Leasing: Disadvantages
- 56** Purchasing Considerations
- 56** What future for the gasoline engine?

## Effect of Inflation on Truck Operating Costs

Over three decades from the 1970s through the 1990s, economic history has shown dramatic changes of inflation. In America, as in other industrialized countries, inflation percentages shot up into the teens in the late '70s, eventually to be mitigated, and by the 1990s, brought down to historic lows in America. And with minimal inflation came low interest rates—always an advantage for business and industry. But whatever the rate of inflation, there is a degree of effect on truck operating costs. In preparing you to cope with the specifics of truck costs, first examine these effects of inflation on business costs in general. Against that background you can better appreciate the effects of inflation on truck costs.

### **EFFECTS OF INFLATION ON BUSINESS OPERATIONS**

<b>Cost Area</b>	<b>Inflation Effects</b>
Costs of Materials, Labor and Supplies	Immediate cost increases.
Monetary Assets: Cash and Receivables	Erodes purchasing power.
Non-Monetary Assets: Land, Buildings, Vehicles and Equipment	Market value is enhanced, but replacement cost increases.
Liabilities: Installment Loans, Mortgages Long-term Debt	Higher interest rates, but payments are made with devalued "Cheap" Money.

Interestingly, a debtor may derive some benefit from inflation. But beyond that, the results are adverse. Put into the perspective of the truck operator, see if you agree with these conclusions about inflation:

1. Purchasing a truck converts eroding cash into a more value-retaining nonmonetary asset.
2. If bought on installment contract, the truck creates a debt, payable with cheapening money.
3. Actual truck market value and eventual trade-in allowance will be enhanced.
4. But the replacement truck will cost more.
5. And operating costs will rise in step with general inflation (or worse, for fuel).

Touching on a different area (to be covered later) the truck buyer also may derive tax savings from accelerated depreciation schedules or via finance leasing, depending on the tax codes. In light of these considerations, the justification for a new truck purchase can go well beyond sheer operating costs.

# LESSON 3

## Lesson Objectives

Well, the cost accounting is over. Take off that green visor and slip on your favorite diesel cap. This lesson will be a definitive show and tell session on the wonders of diesel power. Chances are, some of the words and phrases of Lesson 3 may be strange to you, so definitions and explanations will be interspersed as we move along. Here is a word sample of what's ahead:

- Volumetric Efficiency
- Compression Ratio
- Natural Aspiration
- Turbocharging
- Brake Specific Fuel Consumption
- Cetane
- Octane
- Atomization
- Air-Fuel Ratio

And other words—like torque and horsepower—while in common usage, need more than a speaking acquaintance. How, for example, is horsepower related to torque? (But does it matter? Yes, if you want to be an expert in trucks and diesels.) Really, the purpose of Lesson 3 is to provide a thorough understanding of the workings of gasoline and diesel engines. From all this will come a fuller appreciation of why the diesel works so frugally. But fear not, neither a mechanic nor an engineer will you become (unless already so qualified).

Gasoline was mentioned. Indeed, Lesson 3 will not be entirely a diesel trip. In order to demonstrate positive aspects and benefits of the diesel, it becomes necessary to expose the limitations of the gasoline engine. But in no way is this a deprecation of a great invention and noble power plant. The gas engine lives on, and will propel cars and light trucks for decades to come.

Here are a couple of warm-up observations and related questions for you to think about: (1) Unlike the gasoline engine, a diesel creates no vacuum in the intake manifold. Why is that so? (2) Size for size, a gasoline engine typically turns out 20 to 30 percent more power than its diesel counterpart (turbocharged diesels excluded). Doesn't that fact argue against diesels? You'll find the answers in Lesson 3.

In the concluding pages of Lesson 3 you will find a series of explanations about engine components—general information on those items that often appear in engine specifications.

## LESSON 3—CONTENTS

- 61** Yes, Diesels are Fuel-Efficient—But Why?
- 61** Engine Performance Terms and Measurements
- 63** First Comes Torque, Then Power
- 65** Dr. Otto's Better Idea: Put the Fire Inside
- 67** Limitations of Gasoline Engines
- 69** Compression-Ignition: Dr. Diesel's Wireless Engine
- 69** The Inner Workings of Diesel Engines
- 73** Cetane Rating and Diesel Knock
- 74** Alternatives: Natural Aspiration or Pressure Charging
- 74** No Throttle Plate, No Vacuum
- 75** Diesels and Turbos—Ideal Running Mates
- 76** Diesel Emissions Behavior
- 77** Meet the Phantom Engine Family
- 80** Interpreting Engine Specifications
- 84** Engine Rebuildability—A Matter of Degrees?
- 85** Encore Observations: What Turns Off a Diesel Engine?

## Illustration Acknowledgments

<b>Figure Number</b>	Courtesy of:
<b>3-9, 3-23</b>	Detroit Diesel Corporation
<b>3-12, 3-13</b>	Robert Bosch GmbH
<b>3-21</b>	Mercedes-Benz GmbH
<b>3-24</b>	Volvo Trucks

## Dr. Otto’s Better Idea: Put the Fire Inside

While firemen were busily stoking the boilers of Watt steam engines, Nicklaus August Otto (1832-1891) was developing a piston-type internal combustion engine. Dr. Otto’s new engine featured externally-controlled ignition of the air-fuel mixture. The combustion cycle was achieved in four strokes of the piston: down, up, down, up. In time, with the perfection of electrical ignition and “sparking plugs,” the Otto engine became known as *Spark-Ignited*, or simply gasoline or petrol engines. In modern configuration, Figure 3-6 depicts the four events of the four-stroke-cycle engine (often called “4-cycle”):

**Figure 3-6: Motions of Piston and Valves in the Four-Stroke-Cycle Engine**

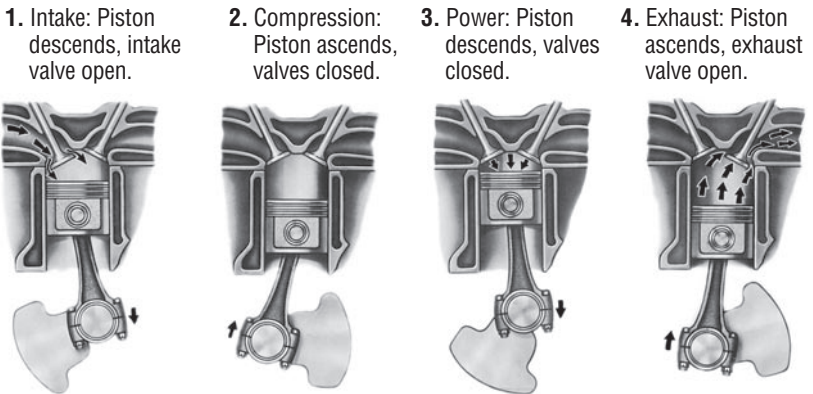

Not shown in the cross-sectional views of Figure 3-6 is the spark plug, usually positioned near the intake valve. Observe the actions of the intake and exhaust valves during the four strokes:

<b>Stroke:</b>	<b>Position of Valves:</b>
1. Intake (down).....	Intake open, exhaust closed.
2. Compression (up) .....	Both valves closed.
3. Power (down) .....	Both valves closed.
4. Exhaust (up) .....	Exhaust open, intake closed.

As the piston nears top dead center (TDC) on its compression stroke, the spark plug fires. Events happen incredibly fast: 20 full cycles a second in an engine turning at 2400 rpm. Given such speed, there is a time lag of the entering air-fuel mixture, the combustion itself can take 20 or 30 degrees of crankshaft rotation, and there is a

# LESSON 4

## Lesson Objectives

The objectives for Lesson 4 lend themselves to brevity, so we're going to take a minute first to comment on the organization of lessons in this course about mid-range diesel trucks. Course IV breaks with traditional TMI lesson sequences, which put the truck chassis together and later deal with engine and driveline. But the situation here is different: The engine is the star of the show. So in this case there is nothing wrong, and a lot of things right, in building the truck around the engine. Lessons 1 and 2 set forth an undeniable case for the engine "whose time has come." Then Lesson 3 presented a thorough comparison of gasoline and diesel engines—citing the many technical benefits of diesel power. Also, Lesson 3 provided insights into the basics of torque and power, plus an introduction to the TMI *Phantom* V8 gasoline and diesel engine family.

As you progress through Course IV, it will become increasingly evident that the presence of a diesel engine will influence the specifications of other components. Driveline differences between gasoline- and diesel-powered trucks will become instantly apparent in the early pages of Lesson 4. We'll start out with the fundamentals of axle gearing and axle ratios, and then go on to demonstrate the effect of the axle ratio on engine power and truck performance.

After you get the feel for driveline gearing and its significance, we'll probe the mysteries of what happens to the power—where it goes, why, and in what amounts. You'll find there are power losses at the engine and in the driveline. Then there are the demands for power to overcome the resistances of hills, air and wind, and the drag of the truck itself. Interestingly, all these factors are reasonably quantifiable. Once you know the procedures, you can quite accurately predict truck

performance. Lesson 4 will show the ways to calculate truck performance ability at highway speeds. After that, you will take a second look at top gear performance ability.

**The Metric Connection.** Adequate coverage of metrics is a basic aim of this course. However, switching to and from metrics tends to interrupt the lesson continuity. Therefore, whenever the principles and procedures are unaffected by the measuring system, examples will be presented only in U.S. customary units. If your system is metrics, or if you want to learn more about metrics, do this: Study the regular lesson; then turn to Lesson 10M, which is devoted to similar examples in metrics. After Lesson 4, turn to 10M for: engine performance curves; geared speed calculations; analyses of performance and power required.

## LESSON 4—CONTENTS

- 89** Axle Ratio—Key to Truck Performance
- 91** Meet the Ratio and Geared Speed Equations
- 95** Power Losses—From Fan to Flywheel
- 98** Power Losses—From Flywheel to Drive Wheels
- 99** Power Demands—At the Drive Wheels
- 100** Rolling Resistance Power Demand
- 101** Air Resistance Power Demand
- 103** Grade Resistance Power Demand
- 104** Effects of Adverse Road Surfaces on Performance
- 105** Calculating Top-Gear Performance
- 108** The Power Balance: Supply versus Demand
- 108** How to Determine Net Power Required
- 114** Mid-Range Diesels: Then and Now

## Grade Resistance Power Demand

Now we're dealing with the force needed to overcome gravity, and the power calculations trace right back to the findings of James Watt. Disregarding the friction of hoists or pulleys, it takes a thousand-pound pull to lift one thousand pounds straight up. The lifting force must equal the weight of the object. Fortunately, trucks are not called upon to do vertical take-offs. But what we do expect of any truck is decent hill-climbing performance. ("Decent," at this point, is intentionally nonspecific.)

Figure 4-10: Truck on a 6% Grade

$$\frac{6 \text{ ft Rise}}{100 \text{ ft Horizontal}} = .06 = 6\%$$

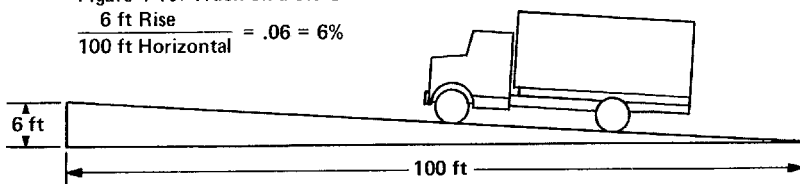

For the truck or car, a hill is an inclined plane, which we all choose to call a grade. Steepness of the grade is often stated in a percentage amount: rise divided by horizontal distance. Thus, one foot of rise per 100 feet of level distance would be a grade of one percent (1%).

Percentage of grade, then, determines the amount of force needed to overcome gravity. For practical calculation purposes (for grades under 20%) each one percent of grade demands a lifting force equal to one percent of the truck's gross weight. Putting that relationship on the basis of 1000-pound amounts, each 1000 pounds of GVW or GCW requires 10 pounds of force for each one percent grade.

Now comes the horsepower connection: One horsepower, you recall, is 33,000 ft-lbs of work per minute. A 10-pound force moving 3300 feet in a minute, then, would be 33,000 ft-lbs—exactly one horsepower. One mph is a speed of 88 feet per minute, so 88 into 3300 feet would give 37.5 mph. Thus, the benchmark for grade power demand is this: One horsepower can move 1000 pounds up a one percent grade at 37.5 mph. The power needed for each mph, then, is  $1/37.5$ th hp, or 0.02667 hp. (The number 375, or its decimal place variants, often appear in truck performance formulas; 375 comes from the division of 88 into 33,000.)

Having traced grade power to its source, all that you need to know for everyday calculations is a table number: Table 11C/11M which gives grade demand power at the drive wheels. Once again, we have

# LESSON 5

## Lesson Objectives

Now it can be told: Your studies in Lesson 4 barely scratched the surface; there is a whole lot more to truck performance than gradeability in top gear. In this lesson we're going to cover the remainder of the performance requirements for mid-range diesel trucks. Here is how we'll be going at it:

**First:** Getting the truck moving from a dead stop; this is known as startability, and it derives from gradeability in the lowest forward and reverse gears. Wherever a truck is to be driven you must be certain that it will have ample performance ability to climb the steepest grades and start from a standstill on the steepest hills or loading ramps. You will learn two distinct procedures concerning gradeability: (1) determining the maximum gradeability for a given truck; and (2) determining the driveline requirements to achieve a designated gradeability.

**Second:** Once in motion, the truck must perform satisfactorily throughout the mid-speed range—between first and top gears. For example, how steep a grade can the truck climb at 40 mph? You will learn how to calculate mid-speed performance ability. And as an adjunct to that procedure, you will meet a graphic device known in the trade as the *shift pattern chart*. You will learn how to make such charts, and learn how they can help you not only in calculating performance, but also in selecting optimum power teams—engine, transmission and rear axle combinations.

**Third and last:** It certainly helps to know the players on the team—in this case, the power team. You will learn about the types of transmissions and axles used with mid-range diesel engines. And there will be some exposure to their internal workings. However, the intent is not for the eyes and mind of the truck mechanic, but rather to give you a basic understanding of the flow of power and the multiplication of torque from transmission to axle shafts.

**The Metric Connection.** See Lesson 10M for metric coverage of: maximum gradeability calculation; gearing the driveline for required gradeability; mid-speed performance ability.

## LESSON 5 — CONTENTS

- 117** Low Speed Performance—Where Torque is King
- 118** How to Calculate Overall Gear Reduction
- 119** How to Calculate Maximum Gradeability
- 121** Gradeability: How Much is Needed?
- 123** How to Gear the Driveline for Required Gradeability
- 125** Transmission Ratios and Geared Speeds
- 127** How to Make a Shift Pattern Chart
- 129** Mid-Speed Performance Ability
- 131** Workings of the Transmission
- 132** Ratio Steps Determine Transmission Types
- 136** Rear Axles: Functions and Fundamentals
- 137** Types of Rear Axles
- 138** Types of Axle Gearing
- 139** Two-Speed Axles
- 140** Tandem Dual-Drive Axles

## Illustration Acknowledgments

- Figure**
- 5-6, 5-8** Transmission Technologies Corporation
  - 5-12** General Motors Corporation
  - 5-13, 5-16** Dana Corporation, Spicer Axle Division
  - 5-17** Meritor Heavy Vehicle Systems, LLC

Engine torque is shared by two identical countershafts, which straddle the mainshaft. Torque to the countershafts is neutralized, being opposite and equal forces. And sandwiched as it is, the mainshaft is cradled instead of being pushed away, as it would be with a single-countershaft transmission.

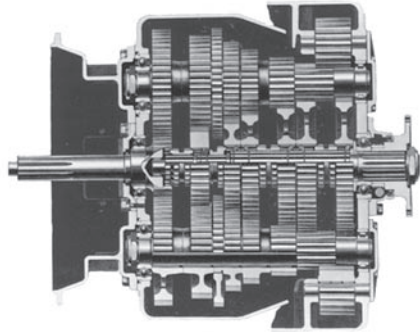

**Figure 5-8:** Twin Countershaft Transmission (Top View). Note the straight spur gears, inherent to dual-countershaft transmission design.

## Ratio Steps Determine Transmission Types

Transmissions are categorized by the nature of their *ratio steps*. Perhaps you’ve heard of, or are familiar with terms such as wide ratio, close-ratio or soft-fourth. If not, no matter, these and other transmission types will be explained.

Transmission specification sheets sometimes quote ratio steps as well as the gear ratios. Often stated as a percentage, the ratio step (or *split*) is a measure of ratio change from one gear to the next. To find the sizes of ratio steps, simply divide each ratio into the next higher numerical ratio. The answer will be one point-something (such as 1.45); drop the numeral one and treat the remaining decimal number as a percentage (45%)—the ratio step. Below is the calculation of splits for our Phantom 5-speed transmission:

Knowing the ratio steps, and without aid of a shift chart, one can precisely calculate engine speed drops at the upshifts. Simply revert to decimal from percentage and reinsert the numeral one: hence, 45% reverts to 1.45. Dividing into the governed speed, 1.45 into 2800 rpm for example, gives 1931 rpm at the 4th to 5th upshift.

Having covered procedures, let’s get back to the operational significance of ratio steps in a transmission.

Phantom Model 5-PD—Ratio Steps					
Gear	Ratio	Shift	Step Calculation	% Step	
5th	1.00	4 to 5	$1.45 / 1.00 = 1.450$	45%	
4th	1.45	3 to 4	$2.26 / 1.45 = 1.559$	56%	
3rd	2.26	2 to 3	$3.83 / 2.26 = 1.695$	70%	
2nd	3.83	1 to 2	$7.08 / 3.83 = 1.849$	85%	
1st	7.08				

# LESSON 6

## Lesson Objectives

Well, you still have a major involvement in the drivetrain for mid-range diesel trucks. A good deal of preparatory work was accomplished in Lesson 5, and now you will make good use of your foundation knowledge. After having become familiar with transmissions and rear axles, the final step will be to study their best applications.

The true truck professional should have a breadth of truck awareness beyond his own product line. That knowledge and awareness should encompass truck makes, differing cab and chassis designs, engines, transmissions and axles. Following that precept, Lesson 6 offers you a broad exposure to contemporary combinations of engines, transmissions and rear axles. A series of shift pattern charts will provide you with visual appraisals of some commonly used drivelines.

And automatic transmissions will merit your close attention also. Mid-range diesel engines and automatic transmissions work well together. The same truck operations that can generate an early payback for the cost of a diesel engine can most probably reap similar economic benefits from the lack of a clutch pedal. Following a brief exposure to the internal parts of automatics, you'll then study their operating characteristics by the use of shift pattern charts.

At the conclusion of the power team studies, you're going to hear another bell ringing on behalf of saving fuel. This time, the equipment will be that most intangible of energy savers—the tender touch of a size 10 throttle foot. As you may appreciate, the driver can make a significant improvement in fuel economy by shifting early and running at part fuel whenever possible.

Actually, there is additional driveline hardware still to be covered: clutches, propeller shafts and power take-offs. These will be the con-

cluding topics of Lesson 6. While any of the three can be important in applications of mid-range diesels, power take-offs often play a critical function—and are given thorough attention here, as your final subject in the drivelines area.

## LESSON 6—CONTENTS

- 145** Selecting the Best Driveline Combination
- 145** Five-Speed Progressive-Ratio
- 147** Five-Speed Progressive Soft-Fourth
- 147** Five-Speed Soft-Fourth & 2-Speed Axle
- 149** Six-Speed Progressive-Ratio
- 150** Seven-Speed Progressive-Direct
- 151** Seven-Speed Progressive-Overdrive
- 152** 9-Speed Equal-Step Transmission
- 153** 10-Speed Equal-Step Transmission
- 154** Those Legendary Roadrangers
- 155** Automatic Transmissions—How They Work
- 157** Automatic Transmission Applications
- 158** 4-Speed Automatic (AT-545)
- 159** Allison MD-Series Automatics
- 161** Size 10C Fuel-Saver—The Light Foot
- 162** Clutch and Propeller Shaft—Vital Connecting Links
- 165** Power Take-Offs: Making a Work Platform
- 166** Types of Power Take-Offs
- 167** Front of Engine PTO: What It Takes
- 167** The Transmission as a PTO Driver
- 169** Types of Transmission-Mounted PTOs
- 170** Power Take-Offs for Automatic Transmissions
- 171** PTO Service Classifications
- 171** Power Take-Off Selection Factors

## Illustration Acknowledgments

- 6-10, 6-24** Allison Transmissions, General Motors Corp.
- 6-15, 6-16** Navistar International Corporation
- 6-17, 6-18, 6-19** Dana Corp., Spicer Driveshaft Division
- 6-20, 6-23** Dana Corp., Chelsea Auxiliary Power
- 6-21** Transmission Technologies Corporation

# Power Take-Offs for Automatic Transmissions

This discussion of power take-offs for automatic transmissions will apply mainly to the Allison Series AT and MD models as used with such typical applications as dump trucks, garbage packers and public utilities trucks. Let’s begin by considering how the automatic differs from the manual transmission. As the PTO driver receives engine torque through the torque converter, the power to the driven unit is cushioned; also, the engine is protected against lugging and stalling caused by sudden load surges. Because of the variable ratio characteristic of the torque converter, the speed of the PTO output shaft changes with load as well as engine speed. Speed and load data are published in the power take-off applications catalogs. To interpret the speed relationships properly, you will have to know the converter model (or stall ratio), the speed and horsepower demand of the driven equipment and the tentative choice of power take-off, including its speed ratio.

Next we will look into the PTO gear design and the aperture types. First of all, think big in terms of gear size, for you are dealing with a gear on the outer circumference of a planet gear assembly. In Allison automatics, the standard SAE 6-bolt aperture is served by the one large PTO driver gear.

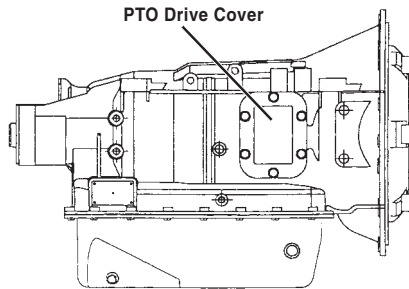

Figure 6-24: Allison AT-545

Allison Transmission PTO Driver Gear Data	Transmission Series	
	AT-545	MD-Series
PTO Torque Ratings: lb-ft .....	200	458
Nm .....	271	657
PTO Location* .....	Right & Left	
PTO Opening Size .....	SAE 6-bolt	
PTO Gear Speed .....	100% x Turbine Speed	
Gear Rotation* .....	Enginewise	

\*Viewed from rear of transmission

With regard to PLV, we spoke favorably of large-diameter PTO gears. The large diameter of an Allison PTO drive gear results in high

# LESSON 7

## Retrospect

Well, you're better than halfway through Course IV by now. As indicated in the earlier lesson objectives, the engine would be the star of the show. And so it has been. You began with a thorough indoctrination on the economic benefits of diesel power. Then came a full discourse on diesel operating advantages. After that came the lessons devoted to the applications technology of the drivetrain—from engine to rear axle.

Now, it's time to change subjects. You will leave the drivetrain and concentrate on the load-carrying function of the truck.

## Lesson Objectives

The load-carrying considerations of a motor truck form two distinct categories: (1) type and weight of imposed loads; and (2) type and capacity of load-bearing components. Quite logically, all considerations begin with the load itself: how big and how heavy. The load determines body type and size, and the needed capacities of chassis and suspension components.

Lesson 7 will give you an extensive exposure to the imposed load side of this twin subject. Lesson 8, then, will provide full details about load-carrying components. Right now, here are the broad subject areas to be covered in Lesson 7:

Where do you begin, in learning about loads on trucks? It all starts with center-of-gravity (CG) and weight distribution. These concepts are fundamental to any vehicle with two or more axles. How much weight goes to each axle, and why? And how can the weights be determined? As you'll see, weight distribution applies to the truck itself,

to bodies and added equipment, and to the payload. Step by step, you will learn the fundamentals of weight distribution and CG, procedures for calculating the amounts of weight going on the axles, and finally you will deal with special cases. Your studies will include tractors as well as the body and payload on straight trucks. In a related aspect, dimensions are of critical importance in tractor-trailer applications; this subject also will be covered as the final topic in Lesson 7.

**The Metric Connection.** See Lesson 10M for metric coverage of: truck weight distribution analysis; tractor-semitrailer weight distribution.

## LESSON 7—CONTENTS

- 175** Fundamentals of Truck Weight Distribution
- 175** Dick, Jane and the Shifty CG
- 177** Distribution of Body and Cargo Weight
- 179** Weight Distribution of Optional Equipment
- 180** Don't Forget the Driver
- 180** Completing the Truck Weight Distribution
- 182** How to Match Body and Wheelbase Lengths
- 185** Making Use of Weight Distribution Tables
- 186** Dealing With Concentrated Loads
- 188** Loads Outside the Wheelbase
- 190** Chassis-Cab Design and Weight Distribution
- 192** Guidelines for Gross Weight Distribution
- 193** Tractors: Distribution of Fifth-Wheel Loads
- 194** Tractor-Semitrailer Weight Distributions
- 196** Tractor-Semitrailer Dimensions
- 199** Putting Together the Well Balanced Truck

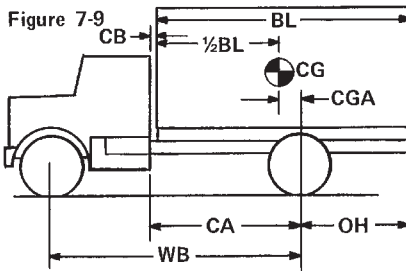
**Dimensional Code**

<b>BL</b>	Body Length
<b>CB</b>	Cab-body Clearance
<b>CG</b>	Body Center
<b>CGA</b>	Center of body to rear axle centerline
<b>CA</b>	Cab to rear axle
<b>WB</b>	Wheelbase
<b>OH</b>	Overhang, rear

Cab-body clearance (CB) should be two inches at minimum. Three inches, however, is usual for van bodies or tanks. A dump body may need four inches or more clearance, if frame flexing is known to be a problem. Designation of body CG at the midpoint ( $\frac{1}{2}$  BL) does, of course, assume a uniform weight from front to rear. Here is a step-by-step replay of the procedure for finding the CGA dimension:

1. Determine the body length in inches (multiply feet by 12).
2. Divide body length by 2 to locate midpoint of body (as shown by CG and dimension  $\frac{1}{2}$  BL on drawing).
3. Determine the desired cab-to-body clearance for the body application (CB on drawing).
4. Then find the CGA distance by subtracting CB and  $\frac{1}{2}$  BL from the CA dimension. Do this in two steps. First, subtract CB from CA; then subtract  $\frac{1}{2}$  BL from the result.

Here, again, is the CGA equation:  $CGA = CA - CB - \frac{1}{2} BL$

For the next example, let's pick a different body length: 20-ft would be appropriate for a closed van body. And, following the usual practice, allow for three inches of cab-body clearance. But an unknown lingers here: CA dimension. It's time for a rule of thumb—two in fact, for fixed bodies and dump bodies:

- **For Fixed Type Bodies:** Approximately 60% of body length should be ahead of rear axle centerline. This makes the CGA equal to about 10% of body length.
- **For Dump or Other Bodies Subject to Weight Shift Rearward:** About 65% to 70% of body length should be ahead of the rear axle. Or putting it another way, the CGA distance should be 15% to 20% of the body length.

# LESSON 8

## Lesson Objectives

At the outset of Lesson 7 it was stated that there are essentially two sides to any discussion of the load-carrying function of a motor truck: (1) the loads imposed and (2) the load ratings of the truck and its load-bearing components. You've made a thorough study of loads and weight distribution. Now it's time to examine the truck chassis and its suspension systems.

Implicit to the specification of any load-bearing component is a capacity rating: How much load can it bear? How many pounds, or how many kilograms? Indeed, you will find the capacity rating to be a constant point of consideration. You have had experience with overall gross weight ratings for trucks and tractors—GVWR and GCWR respectively. Now, in Lesson 8, as we begin to examine suspensions, the letters **GAWR** become all important. Perhaps you already know the full term—Gross Axle Weight Rating. You'll need to have an absolute understanding of the GAWR concept before you can deal intelligently with truck load ratings. So, GAWR comes first on the agenda, by definition and by examples. Be sure you're clear on this point before studying the chassis and suspension components.

After that, first up among the components will be the frame, which we like to think of as the backbone of the truck. You'll learn about frame types and shapes of side rails, materials and measures of relative frame strength.

Next will come front and rear suspensions—the axle systems comprised of the axle, springs, wheels and tires. (Brakes, however, will follow in Lesson 9.) True, you've had some exposure to rear axles as a member of the power team, but here, of course, the emphasis is on load capacity.

While obviously it is important to specify components of suitable size and capacity, other considerations enter the selection process—namely the design features best suited to the job at hand. As examples: Will variable-rate springs handle the loads, or should the truck have auxiliary springs? And as for tire type, will the preference be low- or standard-profile? Your component studies should help materially in forming a knowledge base for your day-to-day judgments on these matters. And piece by piece, these traits of knowledge, procedural skills and seasoned judgment will take shape as the ultimate objective: professionalism.

## LESSON 8—CONTENTS

<b>203</b>	GAWR: Concept and Fundamentals
<b>204</b>	GAWRs and GVWR—A <i>Sometimes</i> Relationship
<b>205</b>	Frame—Backbone of the Truck
<b>206</b>	Typical Frame Design
<b>209</b>	Frame Reinforcements
<b>210</b>	Front and Rear Suspensions: Design Considerations
<b>212</b>	Steering System Considerations
<b>213</b>	Rear Axle Ratings
<b>214</b>	Springs: Functions and Types
<b>218</b>	Spring Load Ratings
<b>220</b>	Stabilizer bars for Stability
<b>220</b>	Soft Ride Suspension Packages
<b>221</b>	Shock Absorbers: Functions and Applications
<b>222</b>	Choosing Tires: Basic Considerations
<b>223</b>	Tire Sizes and Dimensions
<b>224</b>	Tire Types and Size Equivalents
<b>228</b>	Wheels and Rims: Types and Dimensions
<b>230</b>	Wheel and Rim Load Capacities
<b>231</b>	Tire and Rim Compatibility
<b>231</b>	GVWR and GAWRs—The Three-Way Test

## Tire Sizes and Dimensions

Tires of size 9.00-20/F and 10R22.5/F— these are two distinctly different tires that share one point in common: Each has the same maximum rated load capacity. How much do the size designations mean to you? Is one a bias-ply, the other a radial-ply tire? What is the ply rating of each? Get to know tire dimensions and one look at a tire size will reveal the answers to these and other questions. Figure 8-17 shows a side-by-side cross-section of the two tires in question. As you see, the 20-inch tire is tube-type, the 22.5-inch size is tubeless. But note that both tires have the same overall height, or outside unloaded diameter. The sizes 20 and 22.5 are rim diameters, so the difference lies in the rim contours.

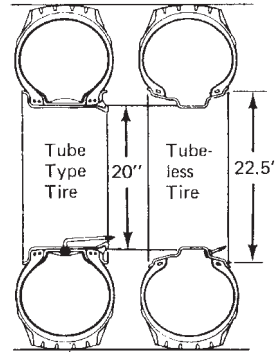
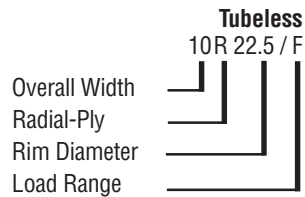
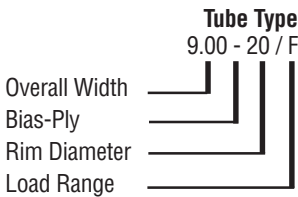

Figure 8-17: Comparative Sizes—Tubes and Tires

Here are the meanings of all parts of the tire size designations:



As you see here, the letter **R** designates a radial tire. Figure 8-18 helps to show the construction differences of bias- and radial-ply tires while Figure 8-19 shows greater detail of a Michelin brand radial tire:

Figure 8-18: Tire Types

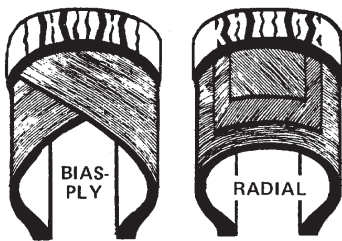
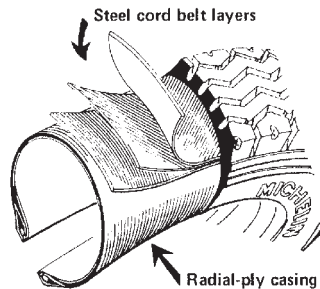

Figure 8-19: Construction of a Radial Tire



# LESSON 9

## Lesson Objectives

In earlier lessons you did intensive studies of what it takes to make a mid-range diesel truck move as intended. Since performance is vital to the successful application of a truck, that topic certainly merited extensive coverage. But every bit as important will be the matter of bringing the moving vehicle to a safe, sure stop under whatever conditions prevail. On that basis, Lesson 9 will be devoted largely to vehicle speed control.

You will be introduced to all the current types of brake systems: hydraulic brakes with vacuum, hydraulic or air boosters, along with full air brakes. Also, you will learn the factors that control brake effectiveness and, of course, you will examine the many components of the various brake systems.

Brake specifications can sometimes be mystifying, so you'll find some useful information that will help to clarify what is behind some of the numbers and terms typically quoted for brakes in truck specification sheets.

During the 1970s, air brake systems went through revolutionary design changes in order to meet performance standards mandated by government regulation. You will develop an appreciation for the forces related to panic-stop braking, as well as the changes wrought by U.S. "121," the air brake safety standard. In the concluding pages of this lesson, there will be general information about safety standards and size-weight regulations.

Perhaps more than any lesson so far, Lesson 9 will move your perspective closer to the vantage point of truck operators and equipment supervisors. By thinking and communicating on the level of truck-users, it becomes easier to match their needs. And when you do that, you will stand to profit from their respect and confidence in you.

## LESSON 9—CONTENTS

<b>237</b>	Truck Brakes: A Matter of Safety
<b>237</b>	Brake Effectiveness
<b>238</b>	Brake Systems for Mid-Range Diesel Trucks
<b>246</b>	Disc Brakes: The New Generation
<b>247</b>	Parking Brakes
<b>248</b>	Interpreting Brake Specifications
<b>249</b>	U.S. FMVSS-121 and Air Brakes
<b>251</b>	FMVSS-121 Summarized
<b>251</b>	FMVSS-121: The Effects on Performance and Hardware
<b>252</b>	Weight Transfer During Braking
<b>253</b>	Finding CG Height of the Loaded Truck
<b>255</b>	Deceleration— or What's the G Value
<b>256</b>	Effect of CG Factor on Weight Transfer
<b>257</b>	Kinetic Power on Downhill Grades
<b>258</b>	The Diesel Engine— How Good a Retarder?
<b>258</b>	Diesel Engine Retarder Devices
<b>259</b>	Engine Exhaust Brakes
<b>259</b>	Driveline Retarders
<b>259</b>	Truck Brake Selection Guidelines
<b>260</b>	Overview of Size, Weight and Equipment Regulations
<b>261</b>	Equipment Regulations
<b>261</b>	Truck Size and Weight Limits

## Illustration Acknowledgments

<b>9-1</b>	Ford Motor Company
<b>9-2, 9-3</b>	Allied-Signal Corporation
<b>9-4</b>	The Volvo Group
<b>9-6, 9-9</b>	Bendix Controls System Group
<b>9-8, 9-12</b>	Raybestos Products Company
<b>9-10</b>	Neway-Anchorlok International
<b>9-11, 9-18</b>	Williams Controls Inc
<b>9-13</b>	General Motors Corporation
<b>9-15, 9-16</b>	Navistar International Corp.

**Hose Couplers**, commonly known as glad-hands, provide a self locking connection between tractors, trailers and converter dollies. Couplers are standardized in size and shape for universal application.

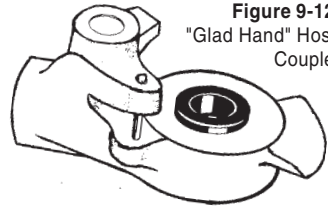

**Figure 9-12:**  
"Glad Hand" Hose Coupler

**Air Reservoirs** are commonly identified as wet and dry air tanks. The wet tank is supplied by the air compressor and accumulates the moisture condensation that is normal to the pressure and temperature changes of the compression and expansion cycles. The wet tank feeds through a check valve to dry tanks for the front and rear brake systems. All air reservoirs are provided with moisture drains. The wet tank is fitted with a safety valve, normally adjusted to blow off at pressure above 150 psi.

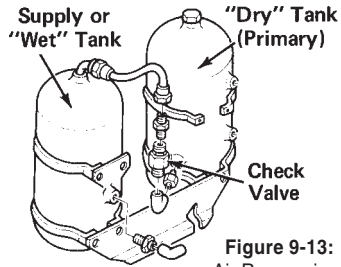

**Figure 9-13:**  
Air Reservoirs

**Moisture Ejection Valve** (splitter valve) automatically expels moisture accumulation from the air tanks. Ejector is actuated by normal brake applications and purges moisture with a minimal loss of air pressure.

**Alcohol Injector** (also known as alcohol evaporator) serves to keep air lines and valves free of ice during subfreezing temperatures. Located between the compressor and wet tank, the injector permits controlled levels of vaporized alcohol to mix with the air stream, thus circulating throughout the system.

## Disc Brakes: The New Generation

First developed for cars and light-duty trucks, the disc brake has become the preferred braking device for hydraulic brake systems as found on the mid-range diesel models of North American truck makers. With hydraulic brake systems, the disc brake is commonly chosen for the rear axle, and is the virtual 100-percent choice for the front axle. Disc brakes feature a disc (rotor) which is subject to a clamping

# LESSON 10

## Lesson Objectives

This is it—your final lesson. Perhaps at first you wondered what there is to say about mid-range diesels that could possibly take 10 lessons. But as it turns out, the greater challenge is saying what needs to be said in a compact 10-lesson textbook. And as you might expect, the last lesson becomes the catch-all for a welter of topics. But that is not to diminish the importance of any one item; you will see from this list that each can be important in the specifications of a truck:

1. Engine temperature control.
2. Fuel systems and diesel fuel.
3. Electrical system; component selection.
4. Options and accessories.
5. Special bodies and equipment; truck productivity.
6. The right truck for the job.

Although here you see a diversity of subjects, the contents page (over) will reveal a thoroughness of treatment in all areas. Some material relates to basic truck design and engineering choices beyond your reach. But as in previous lessons, always there is the motive of helping you to better interpret and evaluate truck specifications. If your better understanding of trucks makes you more authoritative in selling or writing truck specs, you've reaped a reward much bigger than the symbol of a framed certificate—and so have we at TMI! So enjoy this wide-ranging wind-up lesson, and do well on your final test.

## LESSON 10—CONTENTS

- 265** Engine Temperature Control: Why and How
- 268** Pressurized Cooling Systems
- 268** De-Aeration Devices for Cooling Systems
- 269** Thermostatic Fan Control
- 270** Pre-Heaters: Happiness is a Warm Engine
- 270** Corrosion Agents and Corrosion Fighters
- 271** The Diesel Fuel System
- 272** Diesel Fuel Considerations
- 275** Electrical System on the Diesel Truck
- 275** Electrical Terms
- 276** Electrical Components and Functions
- 277** Electrical Storage—It All Starts With the Battery
- 277** Multiple Battery Combinations
- 278** Battery Reserve Capacity and Cycling Durability
- 279** Low-Maintenance and Maintenance-Free Batteries
- 280** Generators and Alternators
- 281** Selecting the Generator/Alternator
- 283** Optional Electrical Equipment
- 284** Options and Accessories
- 285** Special Bodies and Equipment
- 286** Final Result: The Right Truck for the Job

## Illustration Acknowledgments

- 10-3, 4, 5** Society of Automotive Engineers

## Electrical Storage—It All Starts With the Battery

Literally, most engines are started by the electrical energy which the battery supplies, but beyond that vital mission the battery functions as the heart of the electrical system. Replenished by the generator, the battery must have adequate capacity to meet the demands of the cranking motor, and must meet any temporary demands whenever the electrical load exceeds the output capacity of the generator.

Perhaps you are familiar with the term **ampere-hours** as an element in battery specifications. Combining the factors of current flow rate and time, “amp-hours” gave an indication of battery reserve capacity. Equally important, however, is actual cold starting power, which can be expressed either in watts or amperage capability. Thus, in the 1970s ampere-hours gave way to **Cold Cranking Amperes (CCA)** as a prime measure of battery capacity, CCA being the amount of current deliverable for 30 seconds at 0°F (-17.8°C) while maintaining voltage at 1.2 volts or more per cell (7.2 volts from six cells in a 12-volt battery).

But how much battery capacity is needed? That question can haunt truck seller and buyer alike. It is influenced by the amount of cranking torque required, and the torque to crank the engine is affected by piston displacement, compression ratio and the ambient temperature.

As temperature falls, lube oil thickens and friction increases, while battery efficiency drops, as shown:	Temperature		Battery Power Available		Relative Cranking Power Required
	°F	°C	Full Charge	Half Charge	
	80°	27°	100%	46%	100%
	32°	0°	65%	32%	165%
	0°	-18°	40%	21%	250%

Source: Association of American Battery Manufacturers

While the sizing of standard battery equipment is an engineering decision, seller/user judgment must recognize the local operating conditions. Batteries being both costly and weighty objects, there is merit in any combination that meets the given demands with the least penalty to cost and curb weight.

## Multiple Battery Combinations

Looking under the hood of a diesel truck, you can expect to see two or more batteries. Given the high compression ratio of a diesel engine, the cranking power demand is about double that of a gasoline

# LESSON 10M

“THE METRIC CONNECTION”

## Lesson Objectives

This lesson has but one purpose: Presentations of critical examples in the metric system. By this separate treatment, regular lessons are spared the interruptions of metric diversions. But equally important, Lesson 10M concentrates on a continuous metrics only presentation. If you have a need for metric explanations and examples, study the specific parts of this lesson, along with the related topics in the regular lessons. Here is a quick cross-reference to correlate your customary and metric system studies:

---

<b>General Subject</b>	<b>CUSTOMARY: Lesson and Pages</b>	<b>METRICS: Lesson 10M Pages</b>
Fundamentals	Lesson 1, pages 24–25	Pages 291–293
Operating Costs	Lesson 2, pages 45–47	Pages 310–312
Torque, Power	Lesson 3, pages 63–64	Pages 293–295
Torque/Power Curves	Lesson 3, pages 78–79 Figures 3–15, 3–16	Page 297, Figure 10M-3
Geared Speed, Axle Ratios	Lesson 4, pages 91–95	Pages 295–297
Top-Gear Performance	Lesson 4, pages 105–107	Pages 296–299
Power Required	Lesson 4, pages 108–114	Pages 299–300
Maximum Gradeability	Lesson 5, pages 119–121	Pages 300–302
Gearing for Gradeability	Lesson 5, pages 123–125	Pages 302–303
Mid-Speed Performance	Lesson 5, pages 129–130	Pages 304–305
Weight Distribution		
Trucks .....	Lesson 7, pages 175–190	Pages 305–308
Tractors .....	Lesson 7, pages 193–196	Pages 308–310

---

Concepts, principles and procedures are unaffected by differing units, be they feet or metres, pounds or kilograms. Even so, the strangeness of names and numeric quantities gives reason enough for familiariza-

tion exposures to metrics. And while the procedures may be the same, you will see some differences in equations having to do with performance calculations. Finally, truck design preferences vary, so you'll find the tilt-cab 4x2 chassis to be our standard for metric examples — a recognition of predominant usage in those countries where metrics prevail.

## LESSON 10M—CONTENTS

- 291** Fundamentals of Metrics (Système Internationale)
- 293** S.I. Metric Performance Units
- 295** The Torque-Kilowatt Relationship
- 295** How Fast, or What's the Axle Ratio to Be?
- 296** Calculating Top-Gear Performance in Metrics
- 299** Determining Net Power Required (Metrics)
- 300** Calculating Maximum Gradeability in Metrics
- 302** Gearing for Required Gradeability (Metrics)
- 303** Gradients, Grades and Gradeability
- 304** How to Calculate Mid-Speed Performance (Metrics)
- 305** Preparing the Truck Weight Distribution Analysis (Metrics)
- 308** Tractor-Semitrailer Weight Distributions (Metrics)
- 310** A Review: Hybrid and Full Metrics
- 310** Operating Cost Comparison in Metrics
- 311** Fuel Costs in Metrics
- 312** Maintenance Cost Comparison in Metrics

## The Torque-Kilowatt Relationship

This will be similar to the derivation of horsepower from torque: Where one kilowatt equals 60,000 newton-metres per minute, each newton-metre of torque would produce 6.2832 newton-metres of work per revolution. Dividing 60,000 by 6.2832 gives a factor of 9549, and these are the resultant equations for power and torque:

$$\text{Power (kW)} = \frac{\text{Torque (Nm)} \times \text{RPM}}{9549}$$

$$\text{Torque (Nm)} = \frac{\text{Power (kW)} \times 9549}{\text{RPM}}$$

That is the basis for metric performance measurements. Now, putting these kW and Nm units into practice, Figure 10M-3 on page 297 gives performance curves for a familiar engine, the Phantom DT7-200. In S.I. metric measures, its 200 net hp becomes 149 kW, and the 495 lb-ft peak torque becomes 671 Nm. These curves will be your base of reference for all the forthcoming performance calculations.

## How Fast, or What's the Axle Ratio to Be?

In any language, in any measuring system, any consideration about truck performance ought to begin with these one-two questions: How fast should it be geared? And what axle ratio does it need? As an example, we are going to set a target geared speed at 112 km per hour maximum. Engine speed and tire size influence the choice of axle ratio, of course, so these are the required specifications:

Desired Geared Speed:	112 km/h
Engine Speed (Governed):	2800 rpm
Tire Size & Revs per km:	10R22.5, 323 revs (Table 3)
Rear Axle Ratio:	To be determined

Remember, mathematical principles are unchanging, so the ingredients in these next equations have a familiar ring; only the names of units and the numbers differ from the measurements in miles:

$$\text{Ideal Axle Ratio} = \frac{\text{Engine RPM}}{\text{Tire revs per km}} \times \frac{60}{\text{km/h}}$$

$$\text{Ideal Axle Ratio} = \frac{2800}{323} \times \frac{60}{112} = 4.64 \text{ to } 1$$

# Tables & Data

- 314** **Table 1:** Weights & Measures
- 314** **Table 2:** Customary—Metric Conversions
- 315** **Table 3:** Tire Revolutions per Mile and per Kilometre
- 316** **Table 4:** Altitude Effects on Performance
- 317** **Table 5:** Temperature Effects on Performance
- 317** **Table 6:** Driveline Losses and Efficiency Factors
- 318** **Table 7:** Compensation Factors for Power Losses
- 319** **Table 8:** Frontal Areas for Trucks & Trailers
- 319** Air Drag Coefficients for Trucks & Trailers
- 320** **Table 9C:** Air Resistance Power—Customary
- 321** **Table 10C:** Rolling Resistance Power—Customary
- 322** **Table 11C:** Grade Resistance Power—Customary
- 323** **Table 12:** Road Resistances and Correction Factors
- 324** **Table 9M:** Air Resistance Power—Metric
- 325** **Table 10M:** Rolling Resistance Power—Metric
- 326** **Table 11M:** Grade Resistance Power—Metric
- 327** **Table 13a:** Selected Axle Ratio & Geared Speeds
- 327** **Table 13b:** Axle Ratios & Overdrive Geared Speeds
- 328** **Table 13c:** Axle Ratios & Geared Speeds—Low-Profile tires
- 328** **Table 13d:** Axle Ratios & Geared Speeds—With 19.5 Wheels
- 329** **Table 14C:** Weight Distribution to Axles—Customary
- 330** **Table 14M:** Weight Distribution to Axles—Metric
- 331** **Table 15:** Cab-Axle and Body Length Combinations
- 332** **Table 16:** Guide to Dump Body Applications
- 333** **Table 17:** Swing Radius (SR) for Semitrailers
- 334** **Table 18:** Semitrailer Landing Wheel Clearance (LWC)
- 335** **Table 19a:** Tire Capacities—Except Michelin (pounds)
- 336** **Table 19b:** Tire Capacities—Michelin Only (pounds)
- 337** **Table 19M:** Selected Tire Sizes—Metric Capacities
- 338** **Table 20:** Tire and Rim Combinations
- 339** **Table 21:** Typical Electrical Loads—12-Volt System
- 340** Truck Performance Formulas—Customary and Metric
- 343** Glossary of Truck Terms

**TABLE 10C: ROLLING RESISTANCE DEMAND HORSEPOWER AT DRIVE WHEELS (RADIAL-PLY TIRES)**

Gross Weight Pounds	Kg	Vehicle Speed (MPH) and Demand Power (HP)																	
		10	15	20	25	30	35	40	45	47	49	50	52	54	56	58	60	65	70
16000	7258	2.4	3.8	5.3	6.9	8.6	10.5	12.4	14.5	15.4	16.3	16.7	17.6	18.6	19.5	20.5	21.5	24.0	26.7
17000	7711	2.5	4.0	5.6	7.3	9.1	11.1	13.2	15.4	16.3	17.3	17.8	18.7	19.7	20.7	21.8	22.8	25.5	28.4
18000	8165	2.7	4.2	5.9	7.7	9.7	11.8	14.0	16.3	17.3	18.3	18.8	19.8	20.9	22.0	23.1	24.2	27.1	30.1
19000	8618	2.8	4.5	6.3	8.2	10.2	12.4	14.8	17.2	18.3	19.3	19.9	20.9	22.1	23.2	24.3	25.5	28.6	31.7
20000	9072	3.0	4.7	6.6	8.6	10.8	13.1	15.5	18.1	19.2	20.3	20.9	22.0	23.2	24.4	25.6	26.9	30.1	33.4
21000	9526	3.1	5.0	6.9	9.0	11.3	13.7	16.3	19.1	20.2	21.4	21.9	23.1	24.4	25.6	26.9	28.2	31.6	35.1
22000	9979	3.3	5.2	7.2	9.5	11.8	14.4	17.1	20.0	21.2	22.4	23.0	24.2	25.5	26.8	28.2	29.5	33.1	36.7
23000	10433	3.4	5.4	7.6	9.9	12.4	15.0	17.9	20.9	22.1	23.4	24.0	25.4	26.7	28.1	29.5	30.9	34.6	38.4
24000	10886	3.6	5.7	7.9	10.3	12.9	15.7	18.6	21.8	23.1	24.4	25.1	26.5	27.9	29.3	30.7	32.2	36.1	40.1
25000	11340	3.7	5.9	8.2	10.8	13.5	16.3	19.4	22.7	24.0	25.4	26.1	27.6	29.0	30.5	32.0	33.6	37.6	41.8
26000	11794	3.9	6.1	8.6	11.2	14.0	17.0	20.2	23.6	25.0	26.4	27.2	28.7	30.2	31.7	33.3	34.9	39.1	43.4
27000	12247	4.0	6.4	8.9	11.6	14.5	17.7	21.0	24.5	26.0	27.5	28.2	29.8	31.3	32.9	34.6	36.3	40.6	45.1
28000	12701	4.2	6.6	9.2	12.0	15.1	18.3	21.8	25.4	26.9	28.5	29.3	30.9	32.5	34.2	35.9	37.6	42.1	46.8
29000	13154	4.3	6.8	9.5	12.5	15.6	19.0	22.5	26.3	27.9	29.5	30.3	32.0	33.7	35.4	37.1	38.9	43.6	48.4
30000	13608	4.5	7.1	9.9	12.9	16.1	19.6	23.3	27.2	28.8	30.5	31.4	33.1	34.8	36.6	38.4	40.3	45.1	50.1
35000	15876	5.2	8.3	11.5	15.1	18.8	22.9	27.2	31.8	33.7	35.6	36.6	38.6	40.6	42.7	44.8	47.0	52.6	58.5
40000	18144	6.0	9.4	13.2	17.2	21.5	26.2	31.1	36.3	38.5	40.7	41.8	44.1	46.4	48.8	51.2	53.7	60.1	66.8
45000	20412	6.7	10.6	14.8	19.4	24.2	29.4	35.0	40.8	43.3	45.8	47.0	49.6	52.2	54.9	57.6	60.4	67.6	75.2
50000	22680	7.5	11.8	16.5	21.5	26.9	32.7	38.8	45.4	48.1	50.8	52.2	55.1	58.0	61.0	64.0	67.1	75.1	83.5
55000	24948	8.2	13.0	18.1	23.6	29.6	36.0	42.7	49.9	52.9	55.9	57.5	60.6	63.8	67.1	70.4	73.9	82.7	91.9
60000	27216	9.0	14.1	19.8	25.8	32.3	39.2	46.6	54.4	57.7	61.0	62.7	66.1	69.6	73.2	76.9	80.6	90.2	100.2
65000	29484	9.7	15.3	21.4	27.9	35.0	42.5	50.5	59.0	62.5	66.1	67.9	71.6	75.4	79.3	83.3	87.3	97.7	108.6
70000	31752	10.5	16.5	23.0	30.1	37.7	45.8	54.4	63.5	67.3	71.2	73.2	77.2	81.2	85.4	89.7	94.0	105.2	116.9
75000	34020	11.2	17.7	24.7	32.2	40.4	49.0	58.3	68.0	72.1	76.3	78.4	82.7	87.0	91.5	96.1	100.7	112.7	125.3
80000	36288	12.0	18.9	26.3	34.4	43.1	52.3	62.1	72.6	76.9	81.3	83.6	88.2	92.8	97.6	102.5	107.4	120.2	133.6
<b>Speed (Km/h)</b>	<b>16</b>	<b>24</b>	<b>32</b>	<b>40</b>	<b>48</b>	<b>56</b>	<b>64</b>	<b>72</b>	<b>76</b>	<b>79</b>	<b>80</b>	<b>84</b>	<b>87</b>	<b>90</b>	<b>93</b>	<b>97</b>	<b>105</b>	<b>113</b>	
<b>HP per 1000 lbs</b>	<b>0.150</b>	<b>0.236</b>	<b>0.329</b>	<b>0.430</b>	<b>0.538</b>	<b>0.654</b>	<b>0.777</b>	<b>0.907</b>	<b>0.961</b>	<b>1.017</b>	<b>1.045</b>	<b>1.102</b>	<b>1.161</b>	<b>1.220</b>	<b>1.281</b>	<b>1.343</b>	<b>1.503</b>	<b>1.670</b>	

For Bias Ply Tires: Multiply table values by 1.333.  
 Formula: RR Demand HP = 0.75 x [(0.074 x MPH) + 6.7] x MPH x  $\frac{\text{Gross Wt (lbs)}}{375,000}$   
 Text Reference: Lesson 4, Pages 100-101.

---

**GLOSSARY OF TRUCK TERMS**

---

<b>ALTERNATOR</b>	Alternating current electrical generator; a diode rectifier, integrally-mounted or separate, changes output to direct current.
<b>AMMETER</b>	An instrument that indicates current flow in amperes, either discharging (–) of the battery, or charging (+) of the battery.
<b>AUXILIARY SPRINGS</b>	Secondary spring for rear axle; takes effect upon heavy loading. Also known as helper springs. Axle, Rear. See text on Rear Axles for definitions of axle types. BBC. Distance from front bumper to back of cab. Bogie. Tandem axle suspension assembly.
<b>AXLE, REAR</b>	See text on Rear Axles for definitions of these axle types: full-floating, semi-floating, dual-drive tandem, pusher-tandem, trailing axle, single-speed, planetary, double reduction, two-speed.
<b>BBC</b>	Distance from front bumper to back of cab.
<b>BOGIE</b>	Tandem axle suspension assembly.
<b>BORE</b>	The nominal diameter of an engine cylinder and piston.
<b>BRAKE HORSEPOWER</b>	Engine horsepower rating as determined by dynamo-meter testing.
<b>BRIDGE FORMULA</b>	A method of computing legally allowable gross weight (GVW or GCW). Gross weight is based on allowable weight per foot of overall wheelbase length. Cab Forward. Short conventional cab design.
<b>CAB FORWARD</b>	Short conventional cab design.
<b>CAB-OVER (Truck)</b>	Short-BBC design; cab is over engine. CA Dimension. Distance, back of cab to center of rear axle.
<b>CA DIMENSION</b>	Distance from back of cab to centerline of rear axle.
<b>CARGO WEIGHT</b>	Combined weight of all loads, gear and supplies on a vehicle— car, truck or trailer, CE Dimension. Frame length, back of cab to end of frame. (May also be identified as CF or LP.)
<b>CE DIMENSION</b>	Frame length, from back of cab to end of frame.
<b>CG (Center of Gravity)</b>	The weight center or balance point, of an object-truck, body, a passenger, cargo or item of equipment.
<b>CHASSIS WEIGHT</b>	Weight of the empty truck, without occupants or load. (Also known as Curb Weight.)
<b>CLOSE-RATIO (Transmission)</b>	In terms of their numerical ratios, gear ratios are closely stepped.
<b>COE</b>	See Cab-Over (Truck) definition.

# Index

## A

- Acceleration** 67, 255, 294
- Aftercooler / Intercooler** 97
- Air Deflector** 258
- Air Resistance** 101, 102, 121, 129, 320, 324, 340, 341
- Allison Automatic Transmissions**
  - AT and MD 156, 170
  - AT-545 158, 170
  - AT-545R 259
  - MD-3060 160
  - MD-3060R 259
  - MD-3560 160
  - MD-3560R 259
  - PTO drive 170
- Ambient Temperature** 96, 265, 273, 277
- Ampere** 275
- Aspect Ratio** 226
- Automatic Transmissions** 155, 157
- Auxiliary Springs** 215, 216, 232, 253
- Auxiliary Transmissions** 165
- Axle Ratios** 89, 90, 93, 112, 124, 145, 295, 296, 327, 328

## B

- Batteries** 276, 277, 278, 279, 283, 284
  - cold cranking amperes (CCA) 277
  - cranking power demand 277
  - low-maintenance
    - maintenance-free 279
  - series and parallel combinations 277
- Brake Effectiveness** 238
- Brake Specifications** 248–249
- Brake Systems** 238–246
- Brakes**
  - air brakes 237, 241, 251, 260
  - anti-lock brakes 245
  - disc type 246
  - drum area 248
  - emergency brakes 245
  - full air brakes 242
  - hydraulic brakes
    - air-boosted 241, 260
    - hydraulic-boosted 240
    - vacuum-boosted 240
  - lining area 248
  - parking brakes 247
  - s-cam mechanical type 241
  - swept area 249
  - vacuum-hydraulic 239
- Breakaway Ratio** 157
- Breakaway Speed** 119
- Breakaway Valve** 245
- Bridge Formula** 262
- Bumper to Back of Cab (BBC)** 343

**Transmissions**

- 5-speed progressive soft-Fourth 147
- 6-speed progressive-ratio 149
- 7-speed progressive-direct 150
- 7-speed progressive-overdrive 151
- equal-step 153
- equal-step 9-speed 152
- soft-fourth 5-speed 147
- unsynchronized 163
- wide-ratio or deep-ratio 5-speed 145

**Truck Operating Costs** 41**Turbochargers**

- and aftercoolers 97
- and braking 259
- and intercooler 97
- and lobe-blowers 72
- and pressure charging 74
- cutaway of typical turbocharger 75
- turbocharged diesel engines 75–76

**Turning Radius** 213**U****Universal Joint** 164, 165**Unsprung Weight** 219**Unsynchronized Transmissions** 163**V****Variable-Rate Springs** 215–216**Vehicle Speed**

- and transmission gears 125

**Voltage** 275**W****Watt** 64, 65, 103, 275, 292, 293, 294**Weight Distribution** 175

- analysis 232
- and chassis-cab design 190
- and concentrated loads 186
- center of gravity (CG) 176
- completing of truck weight

- distribution 180–182
- fundamentals of 175
- guidelines 199
- guidelines for gross weight distribution 192
- making use of tables 185–186
- of body and cargo 177
- optional equipment 179
- three-way test 233
- to axles (customary) 329
- to axles (metric) 330
- tractor-semitrailer 194
- tractor-semitrailer weight distribution (metrics) 308–310
- tractors
  - fifth-wheel loads 193
  - "water-level" 178

**Weight Limits**

- truck size and weight limits 261–262

**Weight Ratings** 17

- classes and groups 18

**Weight Transfer**

- during braking 252

**Wheel-Cut Angle** 212**Wheels**

- and weight limits 262
- ball seat disc wheel 228
- dual spacing on cast wheels 229
- flange-nut disc wheel 228
- load capacities 230
- types and dimensions 228–230
- wheel markings 230

**Z****ZF Transmissions**

- Ecolite S6-36 150
- S5-42 147
- S5-48 146